



Department of Transportation
Federal Highway
Administration

1200 New Jersey Ave., SE
Washington, D.C. 20590

June 1, 2018

In Reply Refer To:
HSST-1 / CC-142

Mr. Felipe Almanza
TraFFix Devices Inc.
160 Avenida La Pata
San Clemente CA 92672

Dear Mr. Almanza:

This letter is in response to your April 20, 2018 request for the Federal Highway Administration (FHWA) to review a roadside safety device, hardware, or system for eligibility for reimbursement under the Federal-aid highway program. This FHWA letter of eligibility is assigned FHWA control number CC-142 and is valid until a subsequent letter is issued by FHWA that expressly references this device.

Decision

The following device is eligible within the length-of-need, with details provided in the form which is attached as an integral part of this letter:

- SLED mini to TraFFix Water Cable Barrier

Scope of this Letter

To be found eligible for Federal-aid funding, new roadside safety devices should meet the crash test and evaluation criteria contained in the American Association of State Highway and Transportation Officials' (AASHTO) Manual for Assessing Safety Hardware (MASH). However, the FHWA, the Department of Transportation, and the United States Government do not regulate the manufacture of roadside safety devices. Eligibility for reimbursement under the Federal-aid highway program does not establish approval, certification or endorsement of the device for any particular purpose or use.

This letter is not a determination by the FHWA, the Department of Transportation, or the United States Government that a vehicle crash involving the device will result in any particular outcome, nor is it a guarantee of the in-service performance of this device. Proper manufacturing, installation, and maintenance are required in order for this device to function as tested.

This finding of eligibility is limited to the crashworthiness of the system and does not cover other structural features, nor conformity with the Manual on Uniform Traffic Control Devices.

Eligibility for Reimbursement

Based solely on a review of crash test results and certifications submitted by the manufacturer, and the crash test laboratory, FHWA agrees that the device described herein meets the crash test and evaluation criteria of the AASHTO's MASH. Therefore, the device is eligible for reimbursement under the Federal-aid highway program if installed under the range of tested conditions.

Name of system: SLED mini to TraFiX Water Cable Barrier
Type of system: Terminal
Test Level: MASH Test Level ~~TL1~~ ^{2 (TL2)} *UPL 6/18*
Testing conducted by: KARCO
Date of request: April 25, 2018
Date initially acknowledged: April 26, 2018

FHWA concurs with the recommendation of the accredited crash testing laboratory on the attached form.

Full Description of the Eligible Device

The device and supporting documentation, including reports of the crash tests or other testing done, videos of any crash testing, and/or drawings of the device, are described in the attached form.

Notice

This eligibility letter is issued for the subject device as tested. Modifications made to the device are not covered by this letter. Any modifications to this device should be submitted to the user (i.e., state DOT) as per their requirements.

You are expected to supply potential users with sufficient information on design, installation and maintenance requirements to ensure proper performance.

You are expected to certify to potential users that the hardware furnished has the same chemistry, mechanical properties, and geometry as that submitted for review, and that it will meet the test and evaluation criteria of AASHTO's MASH.

Issuance of this letter does not convey property rights of any sort or any exclusive privilege. This letter is based on the premise that information and reports submitted by you are accurate and correct. We reserve the right to modify or revoke this letter if: (1) there are any inaccuracies in the information submitted in support of your request for this letter, (2) the qualification testing was flawed, (3) in-service performance or other information reveals safety problems, (4) the system is significantly different from the version that was crash tested, or (5) any other information indicates that the letter was issued in error or otherwise does not reflect full and complete information about the crashworthiness of the system.

Standard Provisions

- To prevent misunderstanding by others, this letter of eligibility designated as FHWA control number CC-142 shall not be reproduced except in full. This letter and the test documentation upon which it is based are public information. All such letters and documentation may be reviewed upon request.
- This letter shall not be construed as authorization or consent by the FHWA to use, manufacture, or sell any patented system for which the applicant is not the patent holder.
- This FHWA eligibility letter is not an expression of any Agency view, position, or determination of validity, scope, or ownership of any intellectual property rights to a specific device or design. Further, this letter does not impute any distribution or licensing rights to the requester. This FHWA eligibility letter determination is made based solely on the crash-testing information submitted by the requester. The FHWA reserves the right to review and revoke an earlier eligibility determination after receipt of subsequent information related to crash testing.
- If the subject device is a patented product it may be considered to be proprietary. If proprietary systems are specified by a highway agency for use on Federal-aid projects: (a) they must be supplied through competitive bidding with equally suitable unpatented items; (b) the highway agency must certify that they are essential for synchronization with the existing highway facilities or that no equally suitable alternative exists; or (c) they must be used for research or for a distinctive type of construction on relatively short sections of road for experimental purposes. Our regulations concerning proprietary products are contained in Title 23, Code of Federal Regulations, Section 635.411.

Sincerely,

A handwritten signature in black ink, appearing to read "Griffith", followed by the word "(for)" in parentheses.

Michael S. Griffith
Director, Office of Safety Technologies
Office of Safety

Enclosures

Request for Federal Aid Reimbursement Eligibility of Highway Safety Hardware

Submitter	Date of Request:	April 20, 2018	<input checked="" type="radio"/> New <input type="radio"/> Resubmission
	Name:	Felipe Almanza	
	Company:	Traffix Devices Inc.	
	Address:	160 Avenida La Pata San Clemente CA 92672	
	Country:	United States	
	To:	Michael S. Griffith, Director FHWA, Office of Safety Technologies	

I request the following devices be considered eligible for reimbursement under the Federal-aid highway program.

Device & Testing Criterion - Enter from right to left starting with Test Level

!-!-!

System Type	Submission Type	Device Name / Variant	Testing Criterion	Test Level
'CC': Crash Cushions, Attenuators, & Terminals	<input checked="" type="radio"/> Physical Crash Testing <input type="radio"/> Engineering Analysis	SLED mini to Traffix Water Cable Barrier	AASHTO MASH	TL2

By submitting this request for review and evaluation by the Federal Highway Administration, I certify that the product(s) was (were) tested in conformity with the AASHTO Manual for Assessing Safety Hardware and that the evaluation results meet the appropriate evaluation criteria in the MASH.

Individual or Organization responsible for the product:

Contact Name:	Felipe Almanza	Same as Submitter <input checked="" type="checkbox"/>
Company Name:	Traffix Devices Inc.	Same as Submitter <input checked="" type="checkbox"/>
Address:	160 Avenida La Pata San Clemente CA 92672	Same as Submitter <input checked="" type="checkbox"/>
Country:	United States	Same as Submitter <input checked="" type="checkbox"/>
Enter below all disclosures of financial interests as required by the FHWA 'Federal-Aid Reimbursement Eligibility Process for Safety Hardware Devices' document.		
Traffix Devices Inc. and Karco Engineering LLC share no financial interests between the two organizations. This includes no shared financial interest but not limited to:		
i. Compensation included wages, salaries, commissions, professional fees, or fees for business referrals		
iii. Research funding or other forms of research support;		
iv. Patents, copyrights, licenses, and other intellectual property interests;		
vi. Business ownership and investment interests;		

PRODUCT DESCRIPTION

- New Hardware or Significant Modification
 Modification to Existing Hardware

The SLED mini is a non-redirective, gating crash cushion, designed to shield the end of TL-1 and TL-2 Traffix Water Cable Barrier. The SLED mini is free standing, does not require anchoring to the road surface, and can be used on concrete, asphalt, gravel, and compacted dirt surfaces. The surface used for these tests was concrete. The system consists of two main components: one yellow water filled module and one Containment Impact Sled (CIS). The SLED mini has overall dimensions of 85.2 in (2.2 m) long X 23.0 in (0.58 m) wide 32.0 in (0.8 m) tall. The yellow water filled module has overall dimensions of 73.0 in (1.9 m) long (pin to pin) X 18.0 in (0.5 m) wide 32.0 in (0.8 m) tall. The yellow module is manufactured from polyethylene that is UV stabilized. A SLED mini end treatment system for shielded the end of TL-1 and TL-2 TraFix Water Cable Barrier consists of one yellow water filled module connected to the steel CIS. The SLED mini weighs approximately 1300 lbs (590 kg) when the yellow module is filled. The yellow water filled module contains a fill lid, which incorporates a pop-up float water level indicator for visually identifying that the module is filled to the appropriate level. Permanently molded within the plastic modules are three corrosion resistant cables.

The connection between the yellow SLED mini water filled module and the orange and white Traffix Water Cable Barrier modules is the same as the connection between the barrier modules. The modules have a series of eight mating knuckles with vertically aligned concentric holes into which, a steel t-pin is to be inserted. This provides a positive connection between the SLED mini and the Traffix Water Cable Barrier. The yellow SLED mini water filled module is positioned inside the CIS and is positively connected to it with a steel t-pin. The CIS is designed using a steel tube frame and sheet metal construction. The CIS has overall dim. of 85.5 in (2.2 m) long X 23" (0.58 m) wide 25.375 ft (0.6 m) tall. Bolted to the front impact face on the CIS is the directional indicator panel. The directional indicator panel is a square sheet of plastic with directional sheeting on both sides. The panel can be attached to the front face on the CIS and is oriented to display a gore point, pass on the right, or pass on the left marking. Other directional sheeting and markings are available. The directional indicator panel contours to the curved shape on the front impact face on the CIS and is secured by six bolts. The MASH tested and passed SLED mini end treatment, described above, is used in concert with the Traffix Water Cable Barrier as described within the FHWA Eligibility Letters B-271 and B-272.

CRASH TESTING

By signature below, the Engineer affiliated with the testing laboratory, agrees in support of this submission that all of the critical and relevant crash tests for this device listed above were conducted to meet the MASH test criteria. The Engineer has determined that no other crash tests are necessary to determine the device meets the MASH criteria.

Engineer Name:	Alex Beltran	
Engineer Signature:	Alex Beltran	Digitally signed by Alex Beltran DN: cn=Alex Beltran, o=KARCO Engineering, ou=Testing Laboratory, email=abeltran@karco.com, c=US Date: 2018.04.25 09:15:55 -07'00'
Address:	9270 Holly Road Adelanto CA 92301	Same as Submitter <input type="checkbox"/>
Country:	United States	Same as Submitter <input type="checkbox"/>

A brief description of each crash test and its result:

Required Test Number	Narrative Description	Evaluation Results
2-30 (1100C)	Not applicable for non-redirective crash cushion	Non-Relevant Test, not conducted
2-31 (2270P)	Not applicable for non-redirective crash cushion	Non-Relevant Test, not conducted

Required Test Number	Narrative Description	Evaluation Results
2-32 (1100C)	Not applicable for non-redirective crash cushion	Non-Relevant Test, not conducted
2-33 (2270P)	Not applicable for non-redirective crash cushion	Non-Relevant Test, not conducted
2-34 (1100C)	Not applicable for non-redirective crash cushion	Non-Relevant Test, not conducted
2-35 (2270P)	Not applicable for non-redirective crash cushion	Non-Relevant Test, not conducted
2-36 (2270P)	Not applicable for non-redirective crash cushion	Non-Relevant Test, not conducted
2-37 (2270P)	Not applicable for non-redirective crash cushion	Non-Relevant Test, not conducted
2-38 (1500A)	Not applicable for non-redirective crash cushion	Non-Relevant Test, not conducted
2-40 (1100C)	<p>The SLED mini was positioned offset a quarter of the vehicle's width towards the passenger side. The offset position examines the risk of exceeding occupant risk values, vehicle instability, and vehicle yaw movement. The test was conducted using a commercially available 2015 Hyundai Accent 4-door sedan with a test inertial mass of 2,423.9 lbs (1,099.5 kg). The test vehicle impacted the SLED mini at a velocity of 44.40. mph (71.46 km/hr) and at an impact angle of 0.2°. The test vehicle impacted the steel Containment Impact Sled (CIS), pushing it rearward crushing and rupturing the yellow water filled module within the CIS dispersing the contained water. As the vehicle continued forward the adjacent water filled orange and white barrier modules were crushed and ruptured, dispersing the contained water. The vehicle rotated in a clockwise direction about its yaw axis before coming to a controlled stop 27.8 ft (8.5 m) forward and 0.3 ft (0.1 m) lateral from the initial point of impact. The yellow SLED mini modules and orange/white barrier modules remained tethered together via the steel t-pins between adjacent modules which connects directly to the internal molded in steel cables. The impacting vehicle was brought to a controlled stop, remained upright, and did not exhibit vaulting throughout the impact event. The test vehicle's occupant compartment was not penetrated and there was no in cab deformation beyond allowable limits. The maximum roll and pitch angle did not exceed 75° and occupant risk values were within limits per MASH specifications for Occupant Impact Velocity (OIV) and Ridedown Acceleration (RA).</p>	PASS

2-41 (2270P)	<p>The SLED mini was positioned in line with the center of the test vehicle. The inline centered position examines the risk of exceeding occupant risk values, vehicle instability, capacity to absorb sufficient impact energy, and the SLED mini's ability to bring the vehicle to a controlled stop. The test was conducted using a commercially available 2013 Ram 1500 4-door pickup truck with a test inertial mass of 5,000.6 lbs (2,271.0 kg). The test vehicle impacted the SLED mini at a velocity of 43.75 mph (70.41 km/hr) and at an impact angle of 0.8°. The test vehicle impacted the steel Containment Impact Sled (CIS), pushing it rearward crushing and rupturing the yellow water filled module within the CIS dispersing the contained water. As the vehicle continued rearward the adjacent water filled orange and white barrier modules were crushed and ruptured dispersing the contained water. The yellow SLED mini modules and orange/white barrier modules remained tethered together via the steel t-pin between adjacent modules which connects directly to the internal molded in steel cables. The impacting vehicle was brought to a controlled stop 51.4 ft (15.7 m) forward and 5.0 ft (1.5 m) lateral from the initial point of impact, remained upright, and did not exhibit vaulting throughout the impact event. The test vehicle's occupant compartment was not penetrated and there was no measurable in cab deformation. The maximum roll and pitch angle did not exceed 75° and occupant risk values are within limits per MASH specifications for Occupant Impact Velocity and Ridedown Acceleration.</p>	PASS
--------------	---	------

2-42 (1100C)	<p>The SLED mini was positioned at a nominal angle of 5° with the center of the test vehicle. The angle position examines the risk of exceeding occupant risk values, vehicle instability, capacity to absorb sufficient impact energy, and the SLED mini's ability to bring the vehicle to a controlled stop. The test was conducted using a commercially available 2015 Hyundai Accent 4-door sedan with a test inertial mass of 2,405.2 lbs (1,091.0 kg). The test vehicle impacted the crash cushion at a velocity of 44.72 mph (71.97 km/hr) and at an impact angle of 4.9°. The test vehicle impacted the steel Containment Impact Sled (CIS), pushing it rearward crushing and rupturing the yellow water filled module within the CIS dispersing the contained water. As the vehicle continued forward the adjacent water filled orange and white barrier modules were crushed and ruptured dispersing the contained water. The yellow SLED mini modules and orange/white barrier modules remained tethered together via the steel t-pin between adjacent modules which connects directly to the internal molded in steel cables. The impacting vehicle was brought to a controlled stop 47.1 ft (14.4 m) forward and 23.4 ft (7.1 m) lateral from the initial point of impact, remained upright, and did not exhibit vaulting throughout the impact event. The test vehicle's occupant compartment was not penetrated and there was no in cab deformation beyond allowable limits. The maximum roll and pitch angle did not exceed 75°. Occupant risk values are within limits per MASH specifications for Occupant Impact Velocity and Ridedown Acceleration.</p>	PASS
--------------	---	------

2-43 (2270P)	<p>The SLED mini was positioned at a nominal angle of 5° with the center of the test vehicle. The angle position examines the risk of exceeding occupant risk values, vehicle instability, capacity to absorb sufficient impact energy, and the SLED mini's ability to bring the vehicle to a controlled stop. The test was conducted using a commercially available 2012 Ram 1500 4-door pickup truck with a test inertial mass of 5,008.8 lbs (2,272.0 kg). The test vehicle impacted the crash cushion at a velocity of 44.38 mph (71.42 km/hr) and at an impact angle of 5.3°. The test vehicle impacted the steel Containment Impact Sled (CIS), pushing it rearward crushing and rupturing the yellow water filled module within the CIS dispersing the contained water. As the vehicle continued rearward the adjacent water filled orange and white barrier modules were crushed and ruptured dispersing the contained water. The yellow SLED mini modules and orange/white barrier modules remained tethered together via the steel t-pin between adjacent modules which connects directly to the internal molded in steel cables. The impacting vehicle was brought to a controlled stop 50.3 ft (15.3 m) forward and 5.6 ft (1.7 m) lateral from the initial point of impact, remained upright, and did not exhibit vaulting throughout the impact event. The test vehicle's occupant compartment was not penetrated and there was no measurable in cab deformation. The maximum roll and pitch angle did not exceed 75°. Occupant risk values are within limits per MASH specifications for Occupant Impact Velocity and Ridedown Acceleration.</p>	PASS
--------------	---	------

2-44 (2270P)	<p>The SLED mini was positioned at a nominal angle of 20° and the center line of the impacting vehicle was directed at the corner of the adjacent water filled barrier module connected to the SLED mini yellow water filled module. The side angled impact test is to evaluate the SLED mini's ability to bring the impacting vehicle to a controlled stop. This angle and intersection directed the test vehicle into the front of the steel Containment Impact Sled (CIS) at its CIP as defined in MASH for test procedures for Gating Non-Redirective Crash Cushion. The test was conducted using a commercially available 2013 Ram 1500 4-door pickup truck with a test inertial mass of 5,002.2 lbs (2,269.0 kg). The test vehicle impacted the crash cushion at a velocity of 44.56 mph (71.72 km/hr) and at an impact angle of 20.3°. The test vehicle made initial contact with the leading edge of the CIS and the yellow SLED mini water filled module. Upon impact the CIS began to rotate in a counter clockwise direction and began fracturing and dispersing the water contained in the yellow water filled module within the CIS. As the vehicle continued to move forward the adjacent orange and white barrier modules also rotated counterclockwise and were crushed and ruptured dispersing the water contained within the modules. The yellow SLED mini modules and orange/white barrier modules remained tethered together via the steel t-pin between adjacent modules which connects directly to the internal molded in steel cables. The impacting vehicle was brought to a controlled stop 58.8 ft (17.9 m) forward and 31.3 ft (9.6 m) lateral from the initial point of impact, remained upright, and did not exhibit vaulting throughout the impact event. The test vehicle's occupant compartment was not penetrated and there was no in cab deformation beyond the allowable limits. The maximum roll and pitch angle did not exceed 75°.</p>	PASS
2-45 (1500A)	Test for staged attenuator is not applicable.	Non-Relevant Test, not conducted

Full Scale Crash Testing was done in compliance with MASH by the following accredited crash test laboratory (cite the laboratory's accreditation status as noted in the crash test reports.):

Laboratory Name:	KARCO Engineering	
Laboratory Signature:	Alex Beltran	<small>Digitally signed by Alex Beltran DN: cn=Alex Beltran, o=KARCO Engineering, ou=Testing Laboratory, email=abeltran@karco.com, c=US Date: 2018.04.25 09:16:48 -07'00'</small>
Address:	9270 Holly Rd. Adelanto CA 92301	Same as Submitter <input type="checkbox"/>
Country:	United States	Same as Submitter <input type="checkbox"/>
Accreditation Certificate Number and Dates of current Accreditation period :	October 12, 2017 - July 1, 2018	

Submitter Signature*:

Digitally signed by Felipe Alvarez
DN: cn=Felipe Alvarez, o=Traffic Design
Inc, ou=Engineering,
email=felipealvarez@trafficdesign.com, c=US
Date: 2018.04.25 10:29:06 -07'00'

Submit Form

ATTACHMENTS

Attach to this form:

- 1) Additional disclosures of related financial interest as indicated above.
- 2) A copy of the full test report, video, and a Test Data Summary Sheet for each test conducted in support of this request.
- 3) A drawing or drawings of the device(s) that conform to the Task Force-13 Drawing Specifications [[Hardware Guide Drawing Standards](#)]. For proprietary products, a single isometric line drawing is usually acceptable to illustrate the product, with detailed specifications, intended use, and contact information provided on the reverse. Additional drawings (not in TF-13 format) showing details that are relevant to understanding the dimensions and performance of the device should also be submitted to facilitate our review.

FHWA Official Business Only:

Eligibility Letter		Key Words
Number	Date	

MASH Test 2-40 Summary

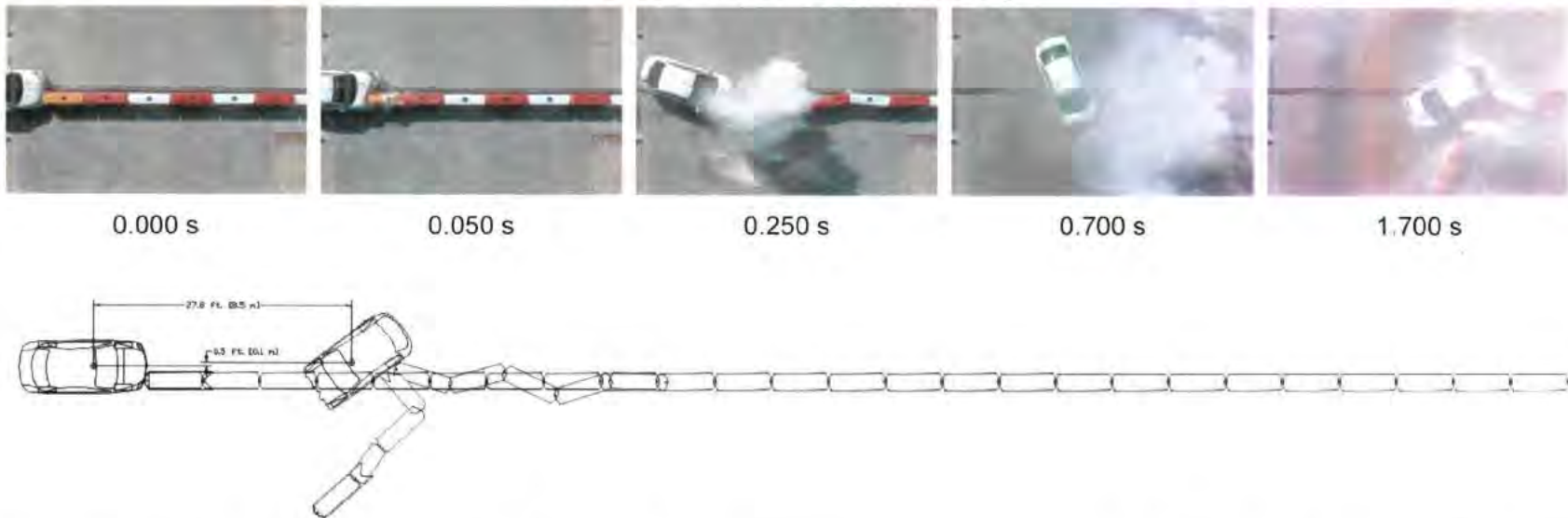

General Information	
Test Agency.....	KARCO Engineering, LLC.
KARCO Test No.....	P37353-01
Test Designation.....	2-40
Test Date.....	10/19/17
Test Article	
Name / Model.....	SLED mini
Type.....	Crash Cushion
Installation Length.....	152.1 ft. (46.4 m)
Terminal Length.....	88.0 in. (2235 mm)
Road Surface.....	Concrete and Soil
Test Vehicle	
Type / Designation.....	1100C
Year, Make, and Model.....	2015 Hyundai Accent
Curb Mass.....	2,487.9 lbs (1,128.5 kg)
Test Inertial Mass.....	2,423.9 lbs (1,099.5 kg)
Gross Static Mass.....	2 640.0 lbs (1,197.5 kg)

Impact Conditions	
Impact Velocity.....	44.40 mph (71.46 km/h)
Impact Angle.....	0.2°
Location / Orientation.....	15.9 in. (404 mm) right of vehicle CL
Kinetic Energy.....	159.7 kip-ft (216.6 kJ)
Exit Conditions	
Exit Velocity.....	N/A
Exit Angle.....	N/A
Final Vehicle Position.....	28.7 ft (8.5 m) downstream 0.3 ft. (0.1 m) left
Vehicle Snagging.....	None
Vehicle Pocketing.....	None
Vehicle Stability.....	Satisfactory
Maximum Roll Angle.....	1.9°
Maximum Pitch Angle.....	-6.6°
Maximum Yaw Angle.....	-97.8°

Occupant Risk	
Longitudinal OIV.....	29.9 ft/s (9.1 m/s)
Lateral OIV.....	2.0 ft/s (0.6 m/s)
Longitudinal RA.....	-3.9 g
Lateral RA.....	1.5 g
THIV.....	29.9 ft/s (9.1 m/s)
PHD.....	3.9 g
ASI.....	0.96
Test Article Deflections	
Static.....	14.3 ft. (4.4 m)
Dynamic.....	Out of View
Working Width.....	15.7 ft. (4.8 m)
Vehicle Damage	
Vehicle Damage Scale.....	12-FD-3
CDC.....	12FDEW2
Maximum Intrusion.....	0.2 in. (5 mm)

Figure 2 Summary of Test 2-40

MASH Test 2-41 Summary

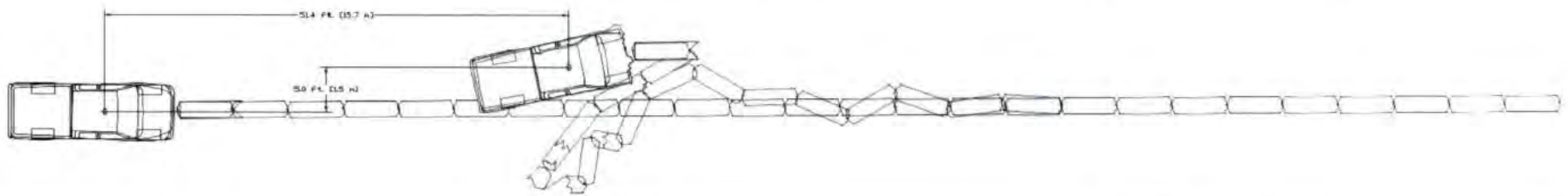
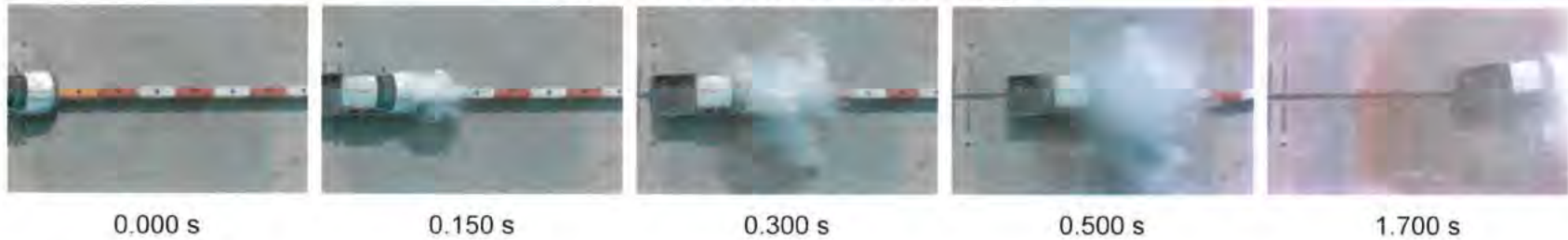

General Information	
Test Agency	KARCO Engineering, LLC.
KARCO Test No.	P37271-01
Test Designation	2-41
Test Date	10/16/17
Test Article	
Name / Model	SLED mini
Type	Crash Cushion
Installation Length	152.1 ft. (46.4 m)
Terminal Length	88.0 in. (2235 mm)
Road Surface	Concrete and Soil
Test Vehicle	
Type / Designation	2270P
Year, Make, and Model	2013 RAM 1500
Curb Mass	4,819.2 lbs (2,186 kg)
Test Inertial Mass	5,006.6 lbs (2,271.0 kg)
Gross Static Mass	5,006.6 lbs (2,271.0 kg)

Impact Conditions	
Impact Velocity	43.75 mph (70.41 km/h)
Impact Angle	0.8°
Location / Orientation	0.3 in. (8 mm) left of vehicle CL
Kinetic Energy	319.8 kip-ft (433.6 kJ)
Exit Conditions	
Exit Velocity	N/A
Exit Angle	N/A
Final Vehicle Position	51.4 ft (15.7 m) downstream 5.0 ft. (1.5 m) left
Vehicle Snagging	None
Vehicle Pocketing	None
Vehicle Stability	Satisfactory
Maximum Roll Angle	5.4°
Maximum Pitch Angle	6.8°
Maximum Yaw Angle	7.2°

Occupant Risk	
Longitudinal OIV	22.0 ft/s (6.7 m/s)
Lateral OIV	1.6 ft/s (0.5 m/s)
Longitudinal RA	-3.5 g
Lateral RA	0.9 g
THIV	22.0 ft/s (6.7 m/s)
PHD	3.6 g
ASI	0.62
Test Article Deflections	
Static	8.4 ft. (2.6 m)
Dynamic	Out of view
Working Width	9.5 ft. (2.9 m)
Vehicle Damage	
Vehicle Damage Scale	12-FD-3
CDC	12FDEW3
Maximum Intrusion	No measurable deformation

Figure 2 Summary of Test 2-41

MASH Test 2-42 Summary

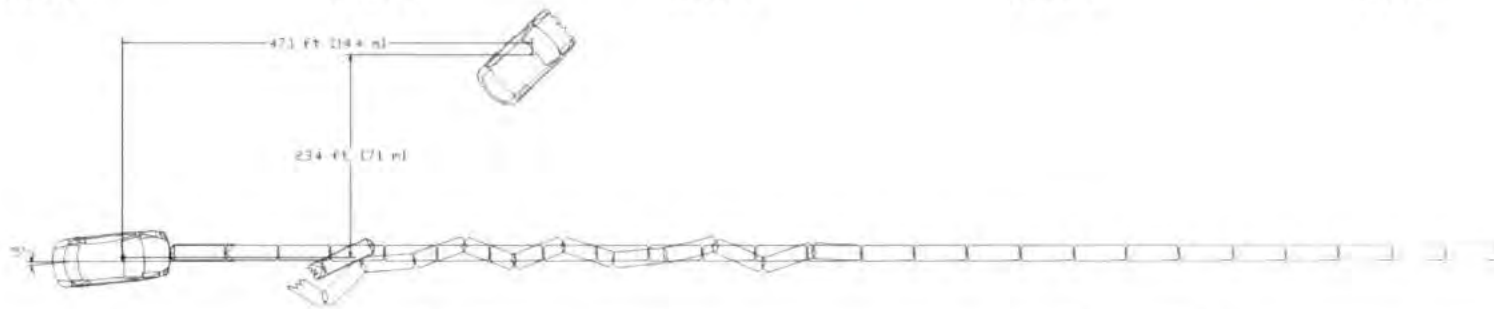

General Information	
Test Agency.....	KARCO Engineering, LLC.
KARCO Test No.....	P37354-01
Test Designation.....	2-42
Test Date.....	10/20/17
Test Article	
Name / Model.....	SLED mini
Type.....	Crash Cushion
Installation Length.....	152.1 ft. (46.4 m)
Terminal Length.....	88.0 in. (2235 mm)
Road Surface.....	Concrete and Soil
Test Vehicle	
Type / Designation.....	1100C
Year, Make, and Model.....	2015 Hyundai Accent
Curb Mass.....	2,478.0 lbs (1,124.0 kg)
Test Inertial Mass.....	2,405.2 lbs (1,091.0 kg)
Gross Static Mass.....	2,570.5 lbs (1,166.0 kg)

Impact Conditions	
Impact Velocity.....	44.72 mph (71.97 km/h)
Impact Angle.....	4.9°
Location / Orientation.....	0.5 in. (13 mm) right of vehicle CL
Kinetic Energy.....	160.8 kip-ft (218.0 kJ)
Exit Conditions	
Exit Velocity.....	9.7 mph (15.6 km/h)
Exit Angle.....	18.7°
Final Vehicle Position.....	47.1 ft (14.4 m) downstream 23.4 ft. (7.1 m) left
Vehicle Snagging.....	None
Vehicle Pocketing.....	None
Vehicle Stability.....	Satisfactory
Maximum Roll Angle.....	-2.3°
Maximum Pitch Angle.....	4.2°
Maximum Yaw Angle.....	12.1°

Occupant Risk	
Longitudinal OIV.....	29.5 ft/s (9.0 m/s)
Lateral OIV.....	1.6 ft/s (0.5 m/s)
Longitudinal RA.....	-3.0 g
Lateral RA.....	2.4 g
THIV.....	29.9 ft/s (9.1 m/s)
PHD.....	3.2 g
ASI.....	1.12
Test Article Deflections	
Static.....	5.3 ft. (1.6 m)
Dynamic.....	5.3 ft. (1.6 m)
Working Width.....	7.1 ft. (2.2 m)
Vehicle Damage	
Vehicle Damage Scale.....	12-FD-3
CDC.....	12FDEW2
Maximum Intrusion.....	0.5 in. (13 mm)

Figure 2 Summary of Test 2-42

MASH Test 2-43 Summary

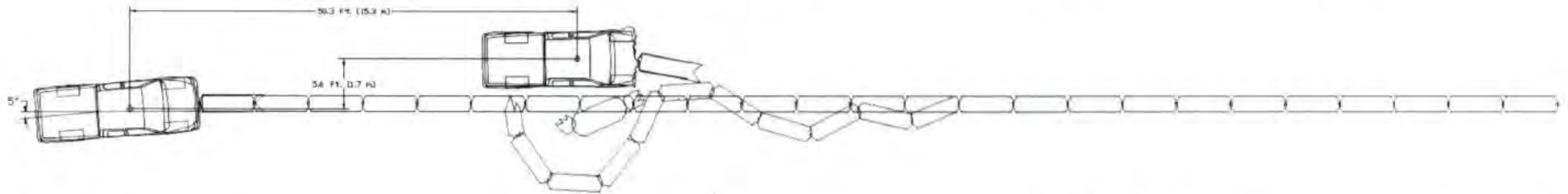

<p>General Information</p> <p>Test Agency..... KARCO Engineering, LLC. KARCO Test No..... P37355-01 Test Designation..... 2-43 Test Date..... 10/20/17</p> <p>Test Article</p> <p>Name / Model..... SLED mini Type..... Crash Cushion Installation Length..... 152.1 ft. (46.4 m) Terminal Length..... 88.0 in. (2235 mm) Road Surface..... Concrete and Soil</p> <p>Test Vehicle</p> <p>Type / Designation..... 2270P Year, Make, and Model..... 2012 RAM 1500 Curb Mass..... 5,014.3 lbs (2,274.5 kg) Test Inertial Mass..... 5,008.8 lbs (2,272.0 kg) Gross Static Mass..... 5,008.8 lbs (2,272.0 kg)</p>	<p>Impact Conditions</p> <p>Impact Velocity..... 44.38 mph (71.42 km/h) Impact Angle..... 5.3° Location / Orientation..... 0.2 in. (5 mm) right of vehicle CL Kinetic Energy..... 329.8 kip-ft (447.1 kJ)</p> <p>Exit Conditions</p> <p>Exit Velocity..... N/A Exit Angle..... N/A Final Vehicle Position..... 50.3 ft (15.3 m) downstream 5.6 ft. (1.7 m) left</p> <p>Vehicle Snagging..... None Vehicle Pocketing..... None Vehicle Stability..... Satisfactory Maximum Roll Angle..... 2.1° Maximum Pitch Angle..... 2.9° Maximum Yaw Angle..... 4.2°</p>	<p>Occupant Risk</p> <p>Longitudinal OIV..... 20.7 ft/s (6.3 m/s) Lateral OIV..... 0.7 ft/s (0.2 m/s) Longitudinal RA..... -2.0 g Lateral RA..... 1.1 g THIV..... 20.7 ft/s (6.3 m/s) PHD..... 2.0 g ASI..... 0.71</p> <p>Test Article Deflections</p> <p>Static..... 9.0 ft. (2.7 m) Dynamic..... N/A (obstructed view) Working Width..... 10.8 ft. (3.3 m)</p> <p>Vehicle Damage</p> <p>Vehicle Damage Scale..... 12-FD-4 CDC..... 12FDEW3 Maximum Intrusion..... No Deformation</p>
--	--	---

Figure 2 Summary of Test 2-43

MASH Test 2-44 Summary

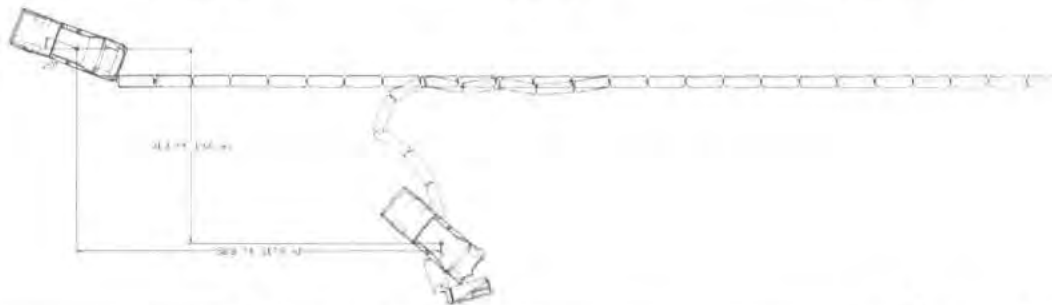

General Information	
Test Agency.....	KARCO Engineering, LLC.
KARCO Test No.....	P37352-01
Test Designation.....	2-44
Test Date.....	10/17/17
Test Article	
Name / Model.....	SLED mini
Type.....	Crash Cushion
Installation Length.....	152.1 ft. (46.4 m)
Terminal Length.....	88.0 in. (2235 mm)
Road Surface.....	Concrete
Test Vehicle	
Type / Designation.....	2270P
Year, Make, and Model.....	2013 RAM 1500
Curb Mass.....	4,856.7 lbs (2,203.0 kg)
Test Inertial Mass.....	5,002.2 lbs (2,269.0 kg)
Gross Static Mass.....	5,002.2 lbs (2,269.0 kg)

Impact Conditions	
Impact Velocity.....	44.56 mph (71.72 km/h)
Impact Angle.....	20.3°
Location / Orientation.....	0.7 in. (18 mm) left of vehicle CL
Kinetic Energy.....	332.0 kip-ft (450.2 kJ)
Exit Conditions	
Exit Velocity.....	N/A
Exit Angle.....	N/A
Final Vehicle Position.....	58.8 ft (17.9 m) downstream 31.3 ft. (9.6 m) right
Vehicle Snagging.....	None
Vehicle Pocketing.....	None
Vehicle Stability.....	Satisfactory
Maximum Roll Angle.....	15.1°
Maximum Pitch Angle.....	15.9°
Maximum Yaw Angle.....	-4.5°

Occupant Risk	
Longitudinal OIV.....	20.0 ft/s (6.1 m/s)
Lateral OIV.....	1.0 ft/s (0.3 m/s)
Longitudinal RA.....	-3.0 g
Lateral RA.....	2.2 g
THIV.....	19.7 ft/s (6.0 m/s)
PHD.....	3.4 g
ASI.....	0.44
Test Article Deflections	
Static.....	33.5 ft. (10.2 m)
Dynamic.....	N/A (obstructed view)
Working Width.....	36.2 ft. (11.0 m)
Vehicle Damage	
Vehicle Damage Scale.....	12-FD-3
CDC.....	12FDEW1
Maximum Intrusion.....	0.6 in. (15 mm)

Figure 2 Summary of Test 2-44

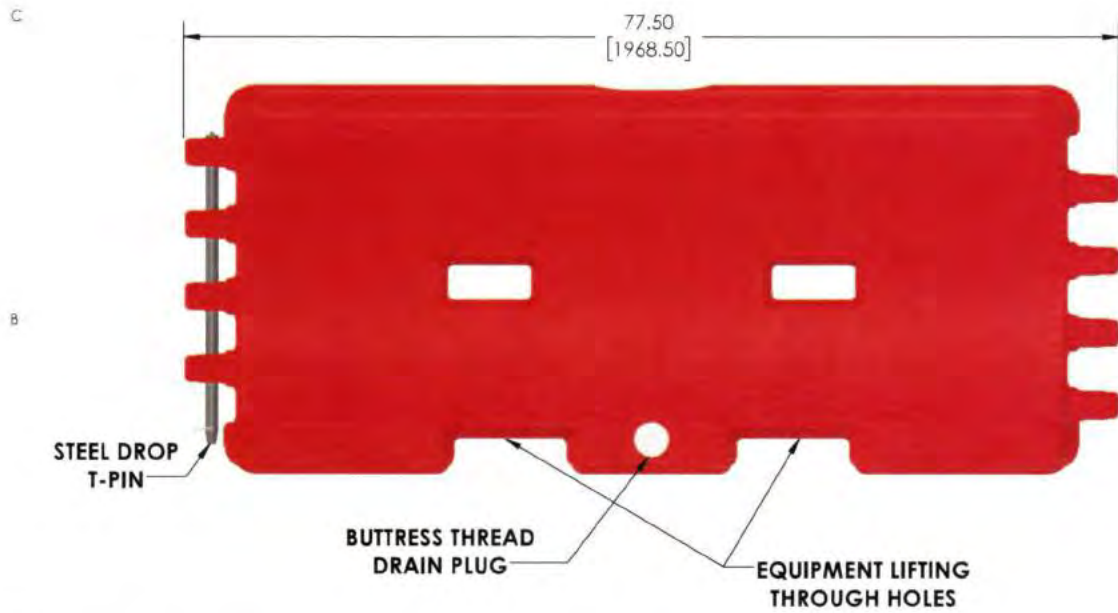
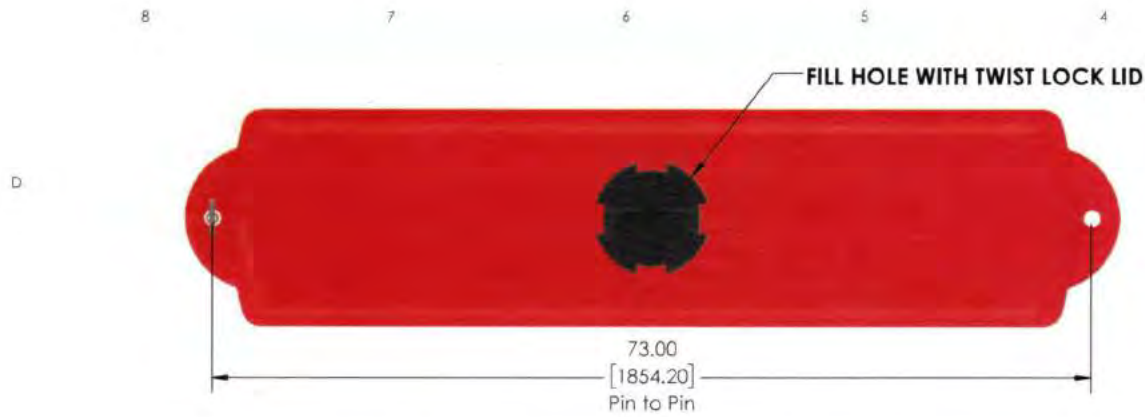

UNLESS OTHERWISE SPECIFIED:
ALL DIMENSIONS ARE IN INCHES (mm).
TOLERANCES:
FRACTIONAL: X/8 & 1/16 (1.6mm)
DECIMAL: .XX ± .002
X.XXX ± .001
DEGREES: ± 0.5°



160 Avenida La Pata
San Clemente, CA 92673
(949) 361-5853
FAX (949) 361-9205
www.traffixdevices.com

TITLE:
**Traffix Water Cable Barrier
With Internal
Molded in Cables**

DRAWN BY:
Ben Longdon
CHECKED BY:
FA
APPROVED BY:
FA

DATE:
3/7/16
DATE:
3/7/16
DATE:
3/7/16

SIZE
B

DWG. NO.
300-236

REV
C

SHEET 1 OF 1

Traffix Water Cable Barrier TL-1 & TL-2
3. Units: Inches [mm]
2. Color: Orange and White
1. Material: Plastic Polyethylene
NOTES: UNLESS OTHERWISE SPECIFIED

8 7 6 5 4 3 2 1

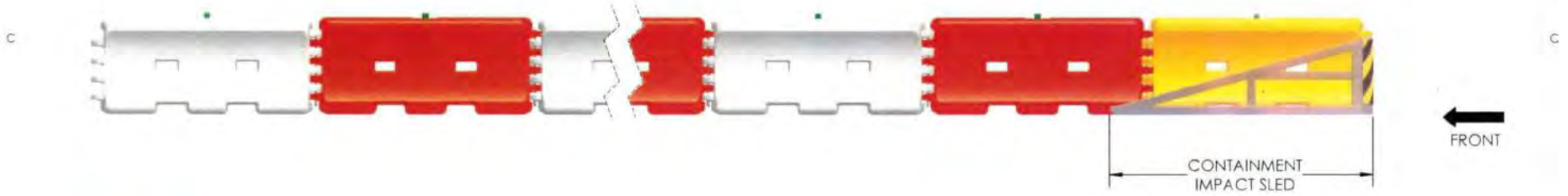

1. Units: Inches [mm]
NOTES: UNLESS OTHERWISE SPECIFIED

UNLESS OTHERWISE SPECIFIED:
ALL DIMENSIONS ARE IN INCHES (mm).
TOLERANCES:
DECIMAL X.X ± .015"
X.XX ± .012"
X.XXX ± .010"
DEGREES ± 0.5°



100 Avenida La Plata
San Clemente, CA 92673
(949) 361-5665
FAX (949) 361-9205
www.traffixdevices.com

DRAWN BY:
Christopher Jaime
CHECKED BY:
TS
APPROVED BY:
FA

DATE:
11/16/16
DATE:
11/16/16
DATE:
11/16/16

SIZE
B

DWG. NO.
300-249

REV
B

SHEET 1 OF 1

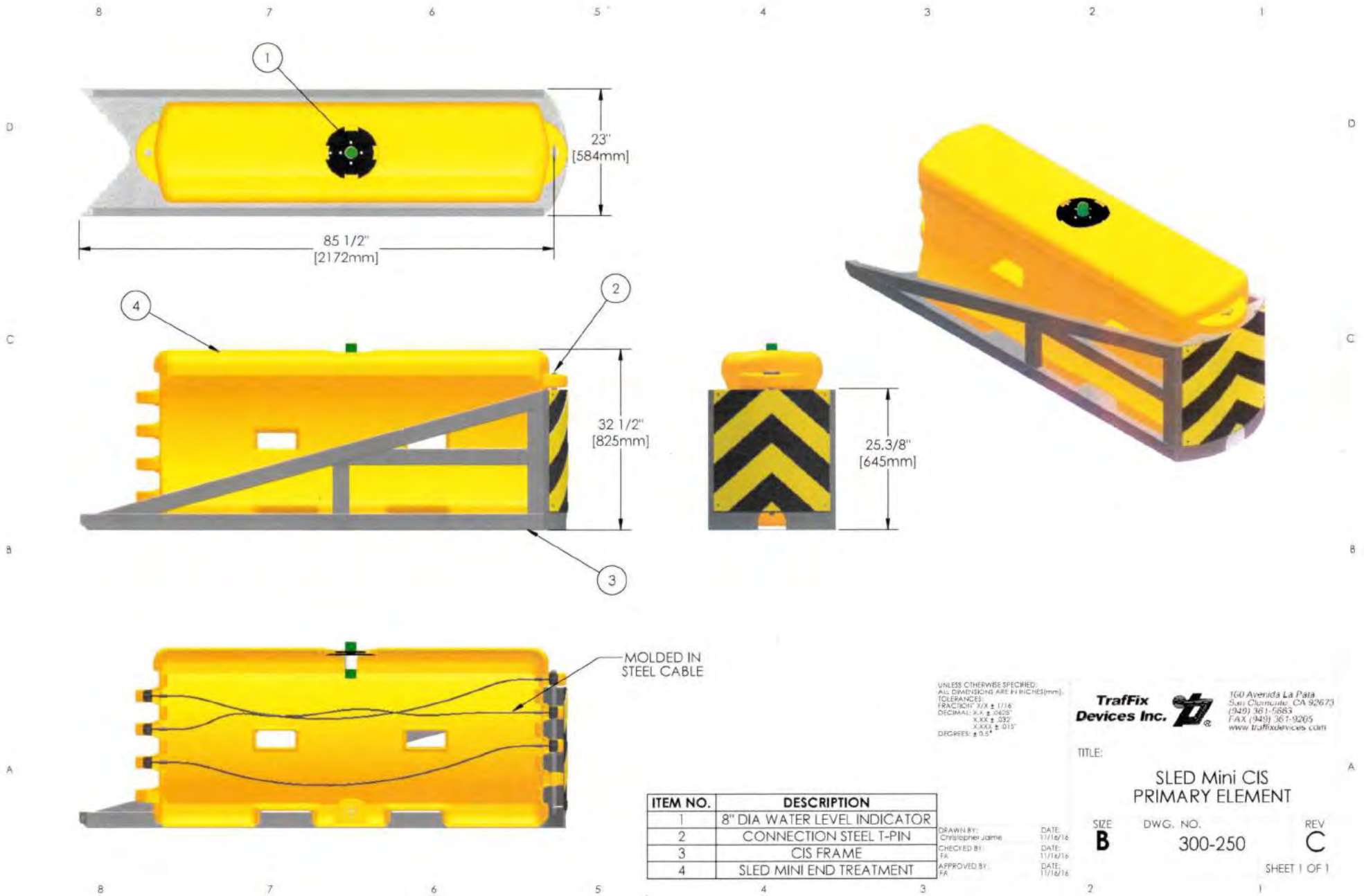

UNLESS OTHERWISE SPECIFIED:
 ALL DIMENSIONS ARE IN INCHES (mm).
 TOLERANCES:
 FRACTIONS: XX ± 1/16
 DECIMAL: X.X ± .005
 X.XX ± .032
 X.XXX ± .015
 DEGREES: ± 0.5°

Traffix Devices Inc.  160 Avenida La Plata
 San Clemente, CA 92673
 (949) 361-5665
 FAX (949) 361-9205
 www.traffixdevices.com

TITLE:
**SLED Mini CIS
 PRIMARY ELEMENT**

DATE: 1/16/16
 DRAWN BY: Christopher James
 CHECKED BY: FA
 APPROVED BY: FA

DATE: 1/16/16
 DATE: 1/16/16
 DATE: 1/16/16

SIZE **B** DWG. NO. **300-250** REV **C**

SHEET 1 OF 1

ITEM NO.	DESCRIPTION
1	8" DIA WATER LEVEL INDICATOR
2	CONNECTION STEEL T-PIN
3	CIS FRAME
4	SLED MINI END TREATMENT

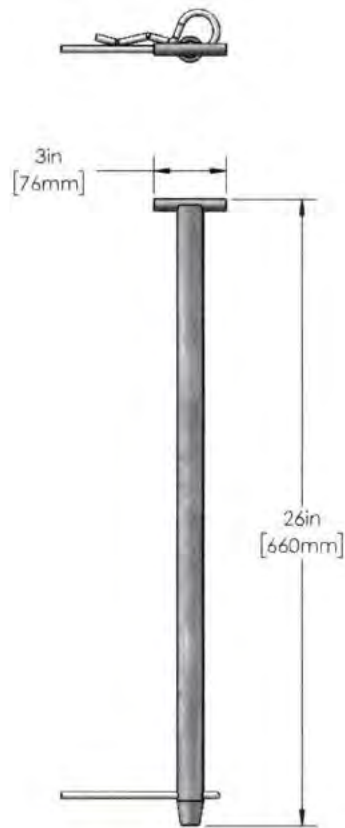

T-PIN

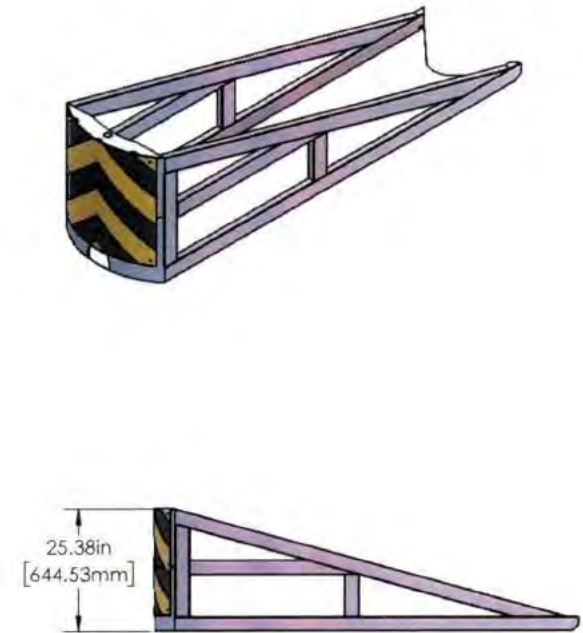
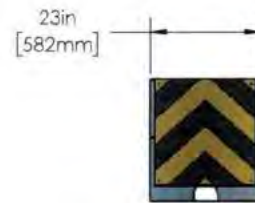
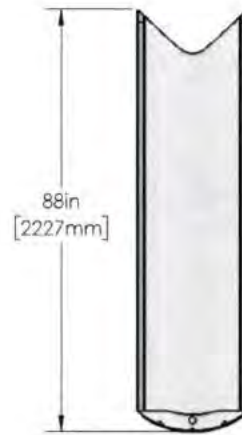

UNLESS OTHERWISE SPECIFIED:
 ALL DIMENSIONS ARE IN INCHES(MM).
 TOLERANCES:
 FRACTIONAL: XX ± 1/16 (1.6mm)
 DECIMAL: XX ± 0.025
 X.XX ± 0.015
 X.XXX ± 0.010
 DEGREES: ± 0.5°



160 Avenida La Plata
 San Clemente, CA 92673
 (949) 361-5863
 FAX: (949) 361-9205
 www.traffixdevices.com

TITLE: SLED Mini End Treatment Hardware

DRAWN BY: Christopher Jome
 CHECKED BY: TA
 APPROVED BY: FA

DATE: 1/14/16
 DATE: 1/14/16
 DATE: 1/14/16

SIZE B

DWG. NO. 300-251

REV B

SHEET 1 OF 1

1. Units: Inches (mm)
 NOTES: UNLESS OTHERWISE SPECIFIED

**SLED mini ATTACHED TO
TRAFFIX WATER CABLE BARRIER**

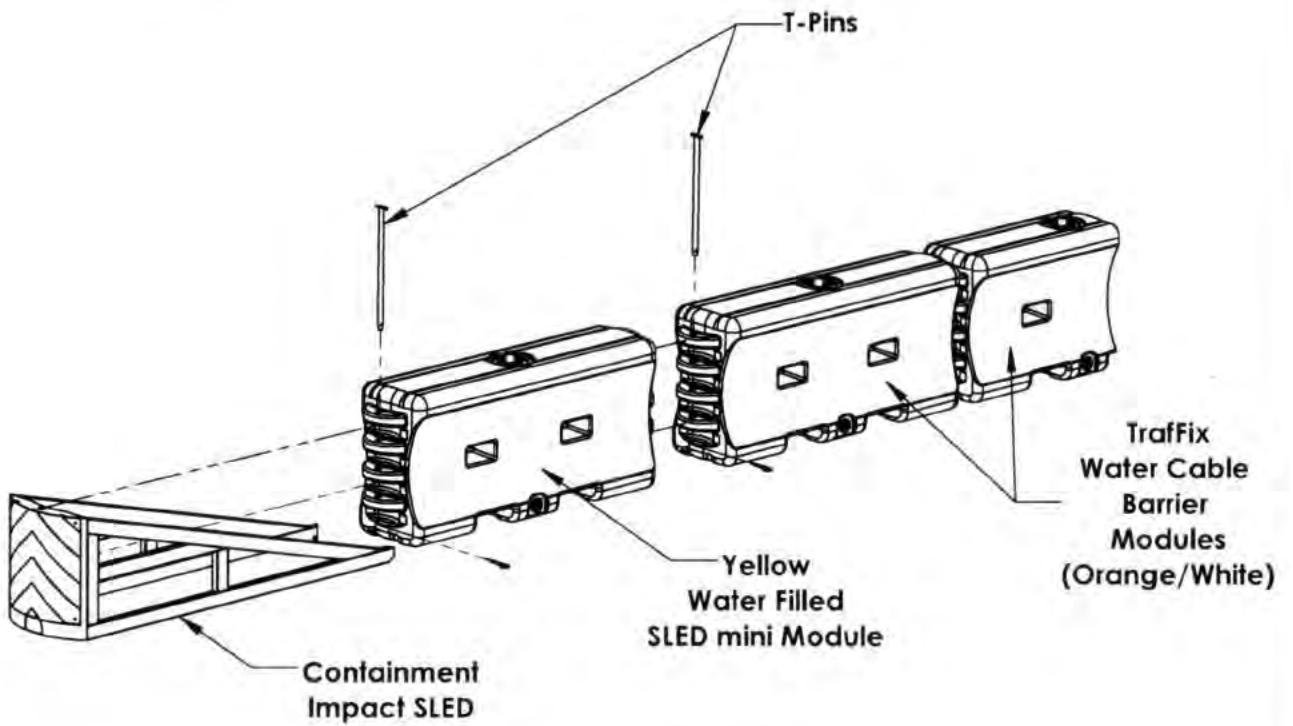
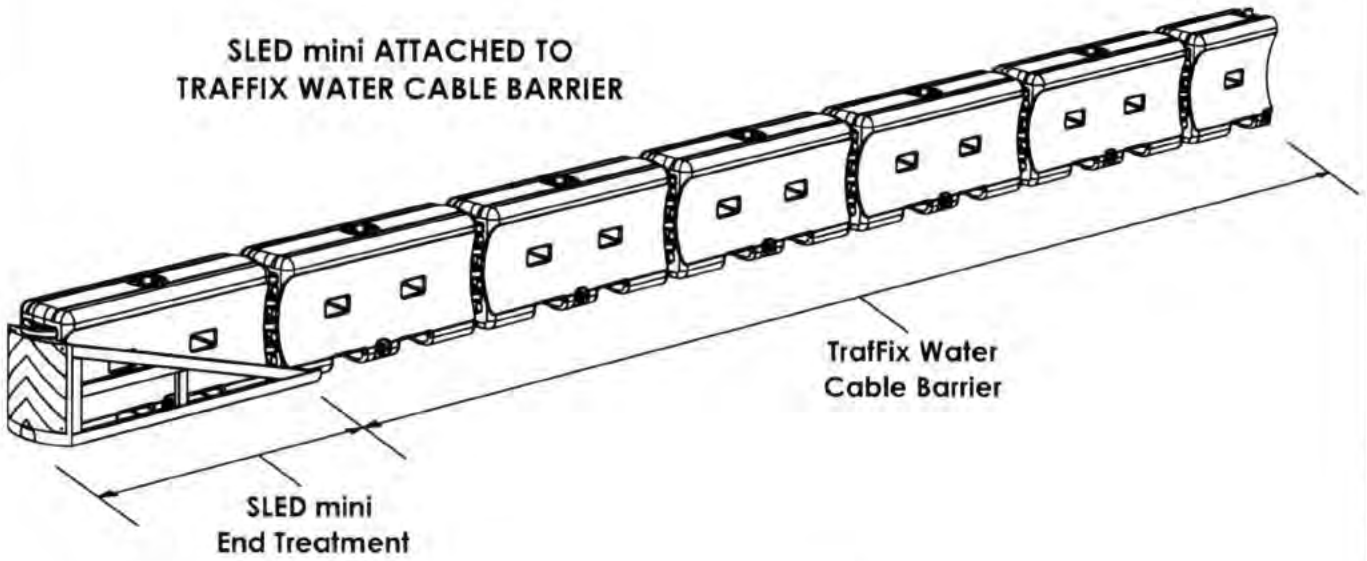

MASH SLED mini End Treatment



INTENDED USE

The SLED mini is a non-redirective, gating crash cushion, designed to shield the end of TL-1 and TL-2 TraFFix Water Cable Barrier. The SLED mini is free standing, does not require anchoring to the road surface, and can be used on concrete, asphalt, gravel, and compacted dirt surfaces. The system consists of two main components: one yellow water filled module and one Containment Impact Sled (CIS). A SLED mini end treatment system for shielded the end of TL-1 and TL-2 TraFFix Water Cable Barrier consists of one yellow water filled module connected to the steel CIS. The SLED mini weighs approximately 1300 lbs (590 kg) when the yellow module is filled. The yellow water filled module contains a fill lid, which incorporates a pop-up float water level indicator for visually identifying that the module is filled to the appropriate level. The modules have a series of eight mating knuckles with vertically aligned concentric holes into which, a steel t-pin is to be inserted. Bolted to the front impact face on the CIS is the directional indicator panel. The directional indicator panel is a square sheet of plastic with directional sheeting on both sides. The panel can be attached to the front face on the CIS and is oriented to display a gore point, pass on the right, or pass on the left marking. Other directional sheeting and markings are available. The directional indicator panel contours to the curved shape on the front impact face on the CIS and is secured by six bolts. The MASH tested and passed SLED mini end treatment, described above, is used in concert with the TraFFix Water Cable Barrier as described within the FHWA Eligibility Letters B-271 and B-272.

Length: 85.2 in (2.2 m)

Width: 23.0 in (0.58 m)

Height: 32.0 in (0.8 m)

The SLED mini for attachment to TraFFix Water Cable Barrier has been fully tested to the procedures of MASH.

ELIGIBILITY

FHWA Eligibility Letters:

CONTACT INFORMATION

TraFFix Devices, Inc.

Corporate Headquarters
160 Avenida La Pata
San Clemente, CA 92673
www.traffixdevices.com

Phone: +1(949)-361-5663

Fax: +1(949)-361-9205

Email: info@traffixdevices.com

MASH SLED mini End Treatment

**TraFFix
Devices Inc.**



SHEET NO.

2 OF 2

DATE:

4/25/18